

mini

User's Manual

DIGITAL BIRD INCUBATOR

Model : PX-03

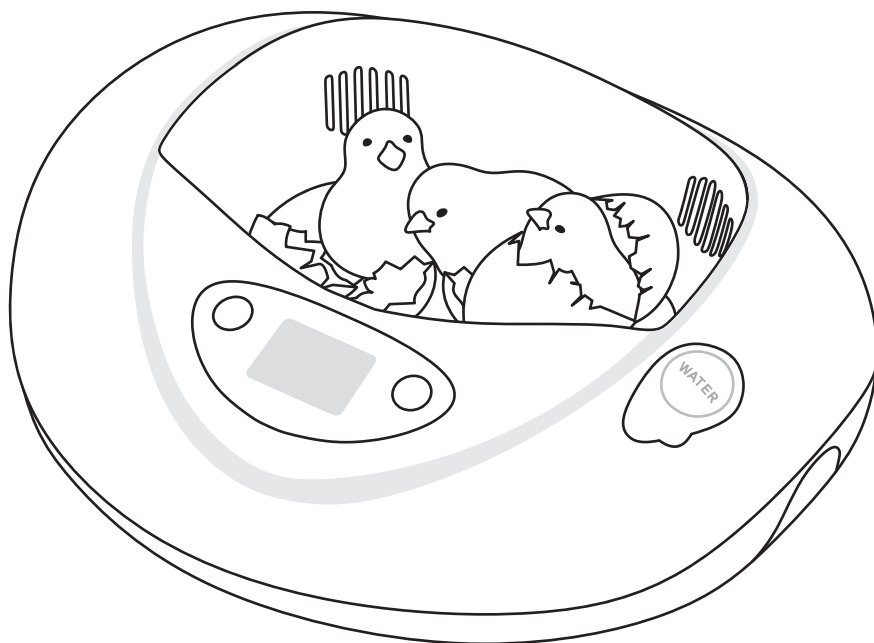

To improve the performance of the product,
specifications are subject to change without prior notice.

Rcom



VIDEO MANUAL

Contents

How to Use Rcom PRO MINI

1. Introduction	
(1) Safety Precautions	3 ~ 6
(2) Identification of Parts and Composition	
(3) Name & Function of Operation Parts	
2. Before Use	
(1) What's an Incubation Room?	7
3. Incubation	
(1) Preparation of incubation / Start incubation	7 ~ 12
(2) How to Set the Incubator for Other Species of Birds	
(3) How to Stop Operating the Incubator	
(4) Return to Factory Settings	
(5) How to turn on/off indoor light	
(6) How to turn on/off the sound	
(7) Pre-and Post-Incubation Management	
4. How to Clean	
(1) How to Disassemble and Clean the Incubator	13
5. Raising of chicks	
(1) Date of Hatching / Date for Stopping Rolling an Egg by Kinds of Birds	14 ~ 19
(2) What Is a Fertilized or Unfertilized Egg?	
(3) Examination of an Egg	
(4) Process on chick incubation	
(5) Making of a Nest for a Chick	
6. Product Information	
(1) Frequently Asked Questions (FAQ)	20 ~ 21
(2) Specification / Guide to Consumer Damage Compensation	

 **The success of incubation may vary according to different factors. The manufacturer and distributor are not responsible for failure of incubation of costly eggs, loss of life, property damage due to negligence of user, remodeling, painting, modification of purpose of use or power failure. When incubating parrot or costly birds please verify the internal temperature (adjust) before use. Please read carefully the instruction manual before use to avoid failures.**

Mark explanation



CAUTION: caution mark for mistakes that can cause loss of animal life, property damage, or product breakdown or damage.



Prohibited



It is necessary to keep



Do not disassemble



Remove the power cord from the outlet.

Tip : References or useful suggestions in using Rcom product.

● Electrical hazards

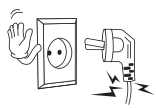

! Do not use a damaged power cord or loose outlet. Risk of electric shock or fire.

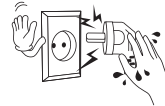

! Do not pull the cord when taking out the power cord, and keep wet hands away from connecting plug. Risk of electric shock or fire.



⊘ Never unplug when using the unit. Operation interruption may result in loss of life inside the unit.



! Do not twist or crush electric cord. Risk of electric shock or fire.

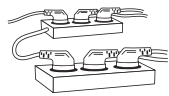

! Do not insert multiple connecting plugs in an outlet. Risk of fire or electrical overload.



! If the machine will be stored for a long time, please clean it before and after storage. Accumulated dust can pose a fire or shock risk.

● Installation, use related precautions



! Do not put a person in the product. He/she may be hurt or killed.

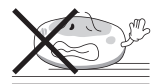

! Do not turn off the power while your pet is in the device. It may be hurt or killed.



! Do not install in dusty or dirty places. Dust or foreign matter may cause electric shock or fire.



! Do not install the product in direct sunlight. There is a possibility of discoloration of the case and rapid temperature rise may cause death of the animal.



! Do not install in wet or humid places. There is a risk of electric shock or fire if water gets inside.

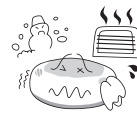

! Avoid places that are too cold or hot and do not place fire or heat machines near the product. There is a risk of fire.



! Do not place the power cord near sources of heat. The coating on the cord may melt and cause fire or electric shock.



! Please install it firmly when installing on cabinet or shelf. Falling or a fall of the product may cause malfunction and serious injury.



! Do not place the product upside down. The product may be damaged.



! Do not allow children to climb on the product.

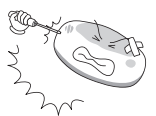

⊘ Never disassemble, repair or modify the product as you please. It may cause electric shock and fire. If you need repair, please contact a service center.



! Be careful not to let foreign substances into the external hole of the product. It may cause electric shock, fire, and physical injury.

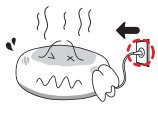

! If any unusual sounds or smoke appear on the product, unplug it immediately and contact a service center. It may cause electric shock or fire.



! Do not cover the ventilating opening. Inner temperature can rise, interrupting incubation.

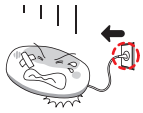

! If you drop it or the case is broken, disconnect the power plug and contact the service center. Using as it is may cause electric shock or fire.

● Cleaning related precautions



! Do not spray cleaning chemicals directly onto the interior or exterior of the product. Spraying directly may increase the possibility of discoloration, cracking, peeling of the printed surface.



! Clean the incubator by a soft cloth with a neutral detergent.

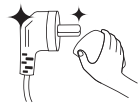

! Wipe the dust on the power plug's pins and contacts with a dry cloth. It may cause electric shock or fire.



! When cleaning, be sure to remove the power cord and clean it with a soft cloth. Do not use chemicals such as wax, benzene, alcohol, thinner or lubricant etc.



! At least once a year, please contact our service center or customer service center to check the machine. Failure to clean dust inside the product for a long period of time may cause fire or malfunction.

● Identification of Parts and Composition

Adaptor

A device to supply 12V power to the main body



Window

For a clear view of the incubation process.
Be careful to prevent it from being scratched or broken.

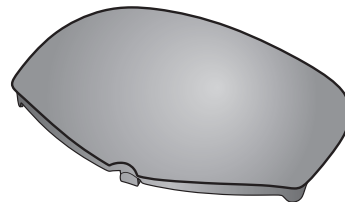

Quail egg tray

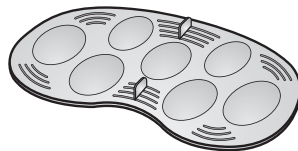

Hatching pad

Insert this tray under the eggs to keep the incubator clean when the eggs start hatching.

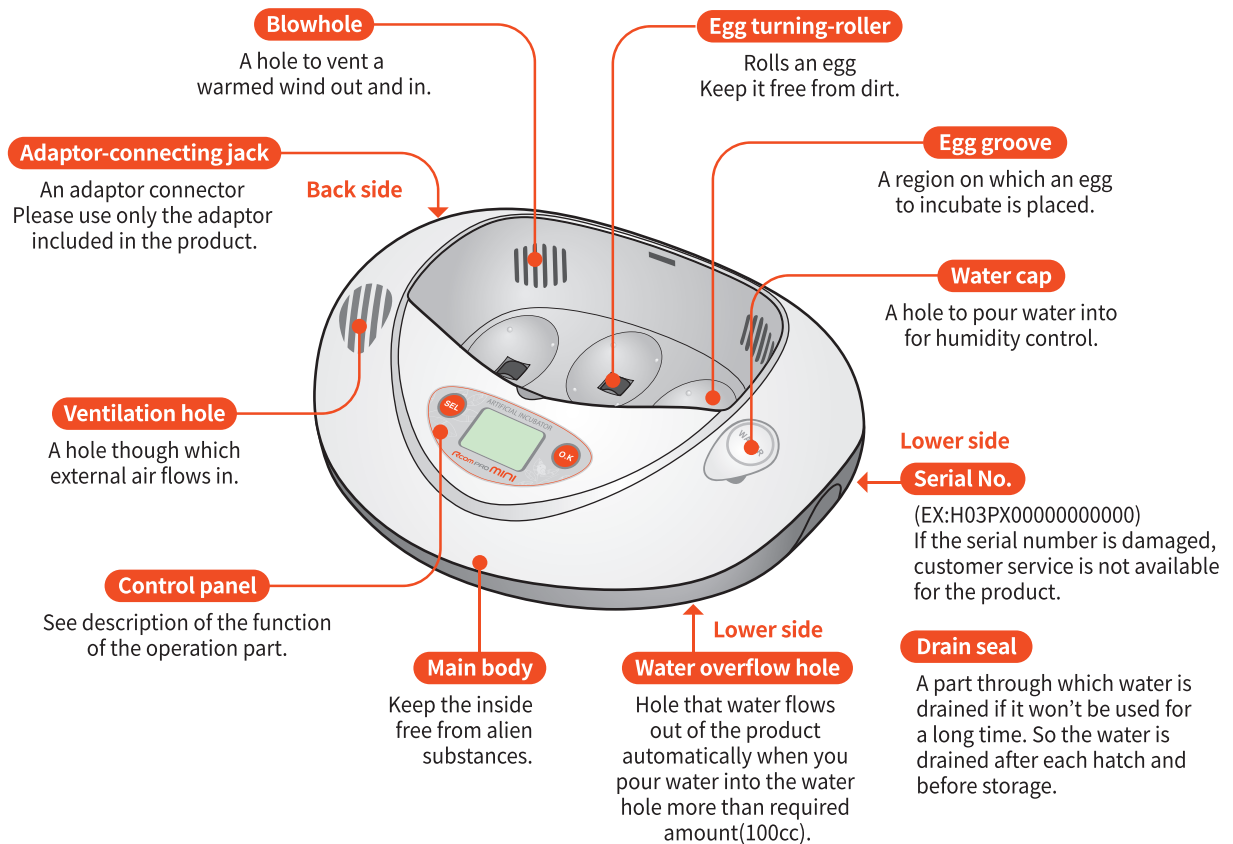
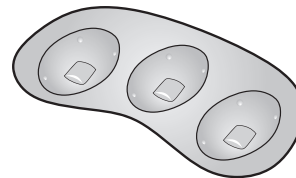

● Name & Function of Operation Parts

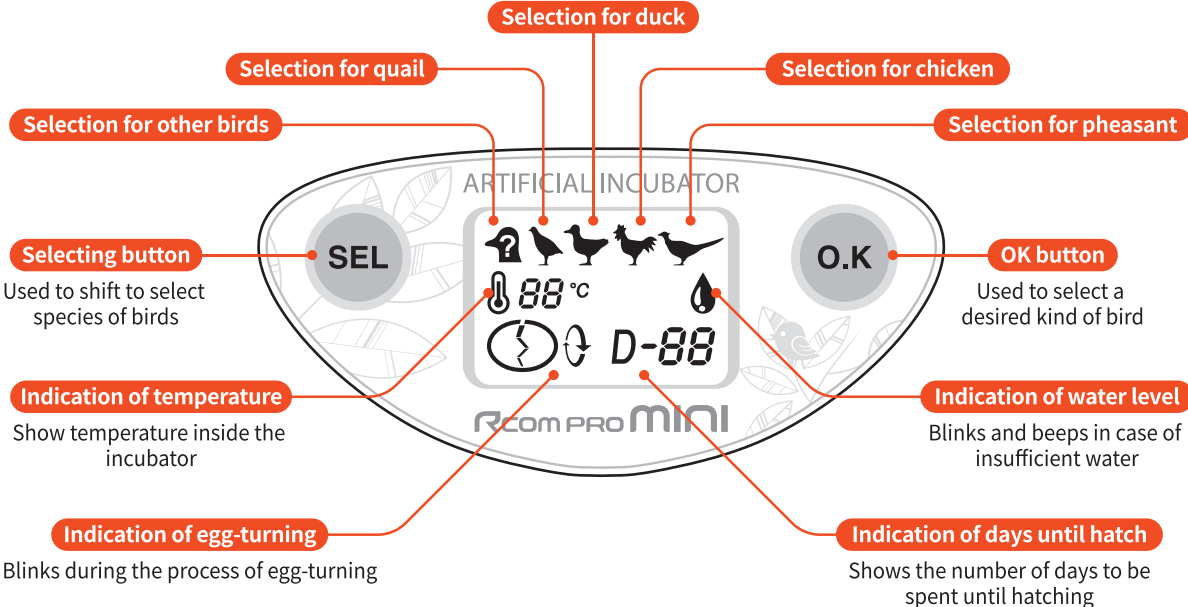

2. Before use / 3. Incubation

(1) What is incubation room?
(1) Preparation of incubation

● What is incubation room?

The Incubation room is a confined space for setting and operating an incubator efficiently. An Incubation Room environment has a considerable effect on hatch rate. Controlling the incubator environment is recommended; there should be little noise or vibration and constant temperature ranging upwards from 22~25°C(71.6~77°F) with small variation in temperature. For optimum performance, pay attention that your incubator isn't exposed to temperature drops compared with daytime. Do not expose the incubators to sunlight during daytime and also ensure that incubator is not placed near drafts or wind from air conditioning units.

⚠ Test the incubator to be sure that the incubator works without any problem before placing eggs in the incubator. Please ensure you remember how to use the machine and maybe re-read instructions.

▶ Insert the adaptor in the connecting jack at the bottom of the main body and put the plug in a socket. The LCD display will come on and show temperature.

Tip: There can be some smell the first time you use the incubator, that is normal.

▶ Lift the lid at the right side of the main body and carefully pour water into the hole. (Maximum 100cc) As it fills with water, a Styrofoam ball rises; if the ball blocks the hole, it means it is full. The light indicating low water will come on about every five days during incubation. You should add tepid water to refill.

Tip: The light for filling up of water can remain for a while after you filled up.

⚠ After filling up the water, never shake or turn over the main body of the incubator. This would cause water to spill inside the incubator and could cause a breakdown.

▶ Open the view window and take out the hatching pad. After that, put a fertilized egg to incubate in the egg groove and then close the view window.

⚠ Do not throw away the hatching pad because it is needed when the eggs hatch.

⚠ Be careful to close the view window completely; if not, the temperature will fail to go up.

Tip: The egg to incubate must be a fertilized egg. see 'What Is a Fertilized or Unfertilized Egg?' on page 14 for description of a fertilized egg.

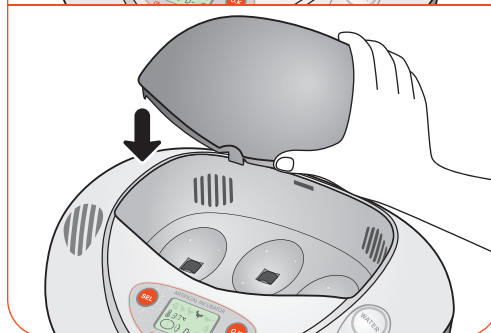
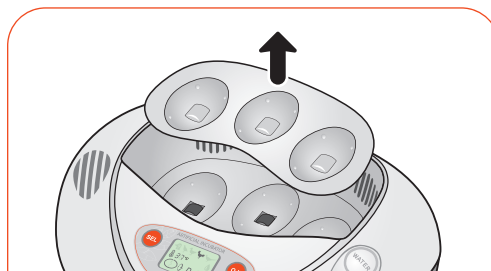
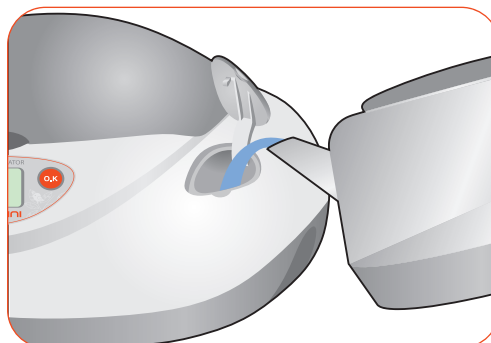
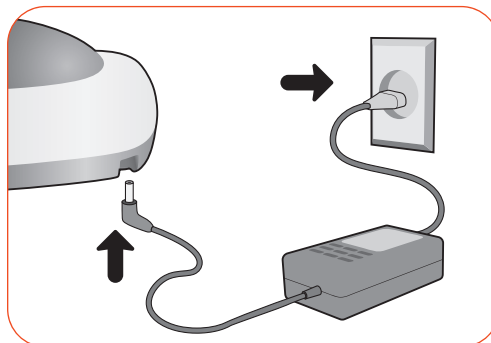

3. Incubation

- ▶ Press the selecting button **SEL** on the control panel and the species icon on the LCD display blinks; Each time the button is pressed, a different species will blink. Select the species you want to incubate.

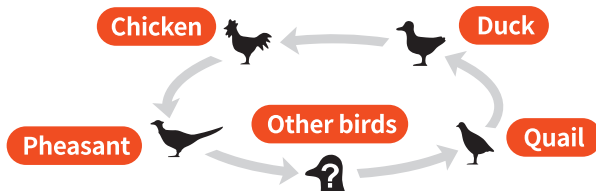

- ▶ Select the kind of birds to incubate and press the OK button **O.K** for about two seconds.

The icon will blink, the light will turn on inside the incubator, and the beeper will sound and the incubation will commence.

- ▶ Now micom will automatically optimize the condition of all functions. It will keep temperature and humidity proper and let the egg turned every an hour. In addition, there will be the alert sound in case of insufficient water, or abnormal temperature.

※ Pre-notice alarm sounds 10 seconds before eggs are turned.

Tip : What is egg-turning?

It is literally to turn an egg and is also called egg exercise. Egg-turning serves to have a healthy chick and helps good egg incubation. It is necessary until three days before a chick hatches.

Tip : Egg Turning Test

If you press OK button for about 5 seconds, egg turning test will be effected once.

- ▶ **Tip :** Rcom PRO MINI does not have an automatic humidity control function. To help birds hatch easily, place some wet paper towels next to the eggs, avoiding the ventilation hole [recommendation - use Rcom's latest thermo-hygrometer, Digilog 3 to check humidity accurately]

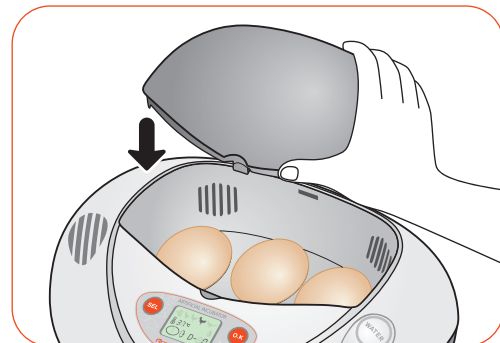
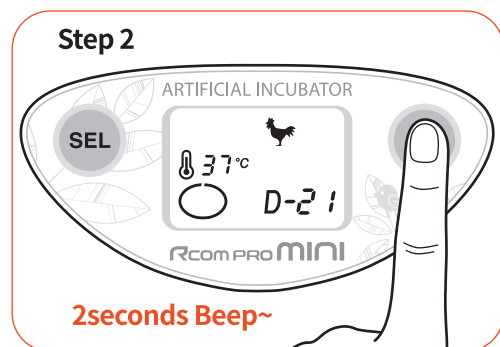
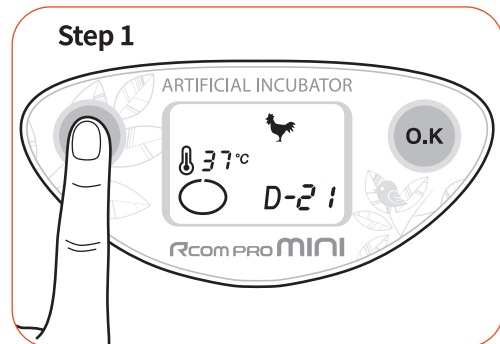

3. Incubation

(2) How to Set the Incubator for Other Species of Birds

● How to Set the Incubator for Other Species of Birds

It is to incubate any other birds than quail, duck, chicken and pheasant.

- ▶ Press the selecting button **SEL** on the operation part to select any other birds. 

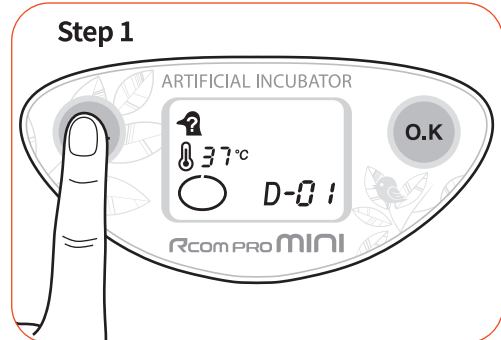

- ▶ Press the OK button **O.K** for a short time of less than one second. And hatching time display **D-01** blinks.

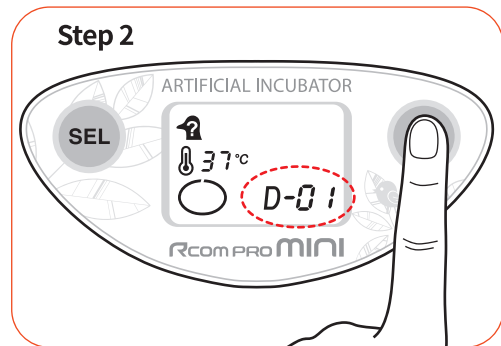

- ▶ Press the selecting button **SEL** to change the number of days of incubation. According to the kind of birds, set up the number of days of incubation by pressing the button several times. (e.g Golden or silver pheasant = 23 days) The number of days of incubation can be set in the range of one to forty days.

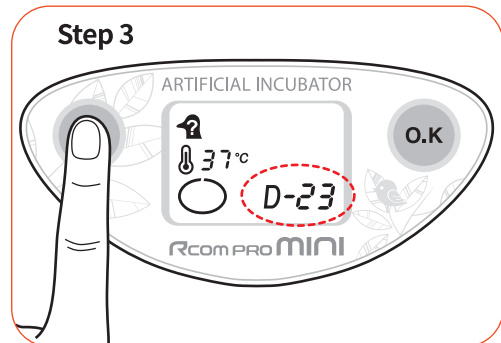

- ▶ Make sure that the desired number blinks, then keep the OK button **O.K** pressed for about two seconds until a beeper is heard to complete setting.

Tip : In case that incubation has interrupted due to an operating error during normal incubation, incubation can be resumed by using the above function to input the number of remaining days until the hatching day. For example, in the case of an egg of which the incubation term is 21 days, if incubation interrupted on the 15th day, all you have to do is input 6 days because 6 days remains until the incubation day (21 - 15 = 6) to resume incubation.

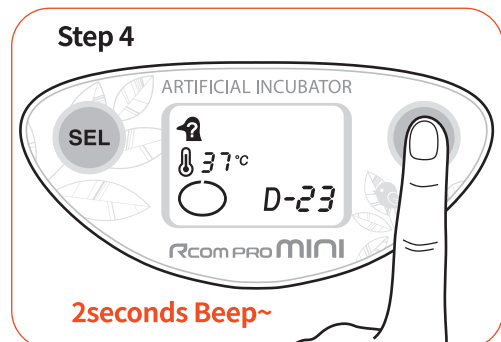

3. Incubation

(3) How to Stop Operating the Incubator
(4) Return to factory settings

● How to Stop Operating the Incubator

! The following operation is prohibited exclusive of special cases.
If normal operation is interrupted by this operation, it can kill an egg.

Tip : Stop incubation only when

The eggs have died and you need to restart the whole incubation process.
The eggs may have died because of a long time power failure, or faulty eggs.
The incubator may need to be reset if the original setting was for an incorrect number of incubation days.

! Short term power failure may or may not kill an egg if the room is at a mild temperature.
In case of short power failure, continue incubation until the fixed date.

Tip : Although power is off and on due to power failure or carelessness, the incubator may maintain the previous setting, if the interruption was short.

► keep two buttons on the operation part pressed at the same time over five seconds, and incubation will stop with a beeper.
Here, the light will be turned off inside the incubator.

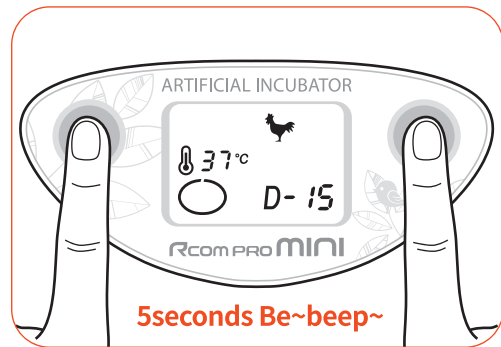

● Return to Factory Settings

► It is for returning to the factory default setting.

► It is for initializing the incubator setting or calibration to the factory settings when you handle the incubator improperly so that the value has changed. Unplug the power supply and hold OK button and re-plug the power supply as shown on picture. Then, rt will show on the display, and the incubator will be initialized to factory setting.

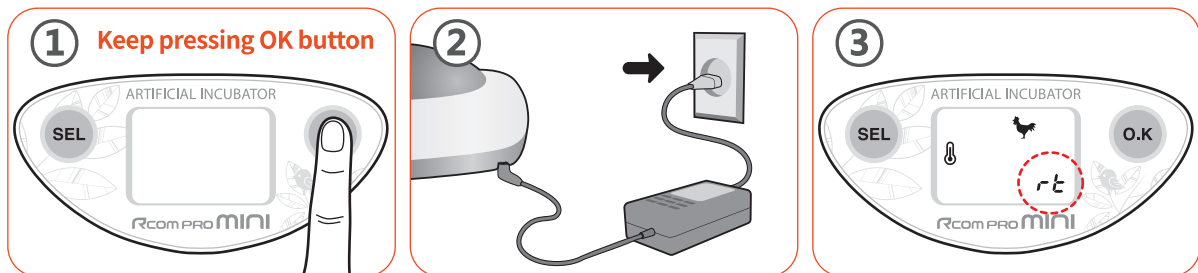

3. Incubation

- (5) How to turn on/off indoor light
- (6) How to turn on/off the sound

● How to turn on/off indoor light

- ▶ During incubation, push the **SEL** button 3 times in quick succession.
- ▶ The screen will blink 3 times. Then indoor light will be turned off.
- ▶ To turn back on, push **SEL** button 3 times during incubation. The screen will blink 3 times. Then indoor light will be turned on.

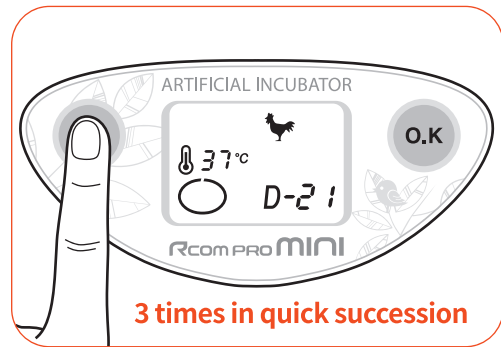

● How to turn on/off the sound

- ▶ During incubation, push the **O.K** button 3 times in quick succession.
- ▶ The screen will blink 3 times. Then sound will be turned off.
- ▶ To turn back on, push **O.K** button 3 times during incubation. The screen will blink 3 times. Then sound will be turned on.

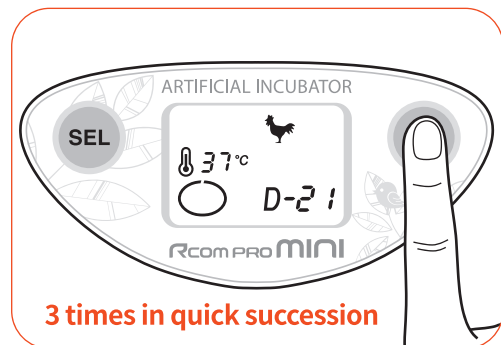

Tip : Button and egg turning sounds can be turned on/off.
But alarm sound cannot be turned off (alarm sound is always on).

3. Incubation

(7) Pre-and Post-Incubation Management

- ▶ When egg- turning is over 18 days later (in case of chicks), open the view window and pick out the eggs carefully and put the hatching pad inside of incubator. After that, put the eggs on the pad and close the view window. This is to prevent alien substances that came out of the egg during hatching from entering the roller or sticking to the main body.

Tip : The incubator turns off the egg- turning indication  on the LCD display when the time of egg-turning is over. This is the time to place the hatching tray in position for hatching.

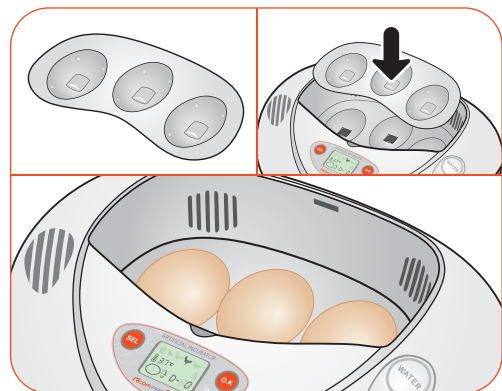

- ▶ When the egg begins to hatch, it is desirable not to open the view window frequently. On opening the view window, moisture and warm air may leak out. Low humidity can cause dried-up feathers of the chick to stick to the shell, which prevents the chick from getting out of the egg.

Tip : It takes about 12 hours for chicks to get out of the egg completely after eggs have pipped. Don't open the view window even if the chicks seem to have difficulty getting out of eggs.



- ▶ After chicks hatched, leave them in the main body for about a day. They may dry their feathers and take a rest for the period of time. Here, don't feed them. A chick is born with nutriments so that they need not to be fed for about one to two days.

Tip : The hatching can be delayed about 2~3 days according to the conditions of egg. When the date of hatching is over, the over date is indicated in LCD displayer.

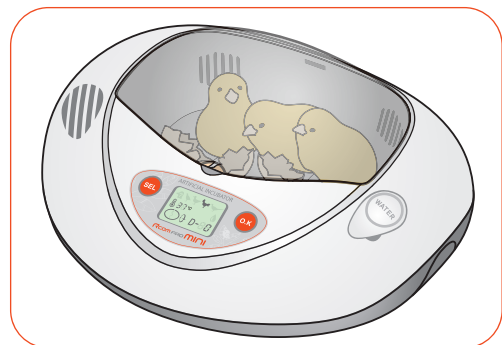

- ▶ A day after their hatching, get them out of the incubator to move into a nest. The packing box of the product can be used as a nest.

 **Be sure to remove hatching tray and make the incubator clean.**

Tip : See 'How to Make a Chick a Nest' on page 18.

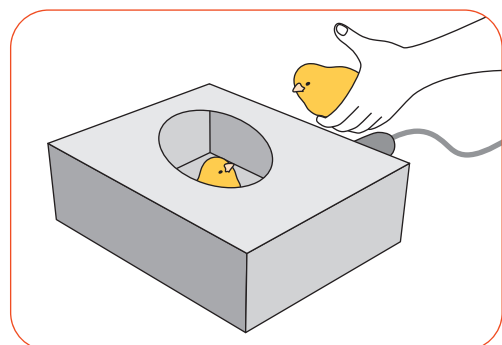

4. How to Clean

(1) How to Disassemble and Clean the Incubator

● How to Disassemble and Clean the Incubator

- ▶ Pull the plug out of the socket and detach the adaptor from the main body.

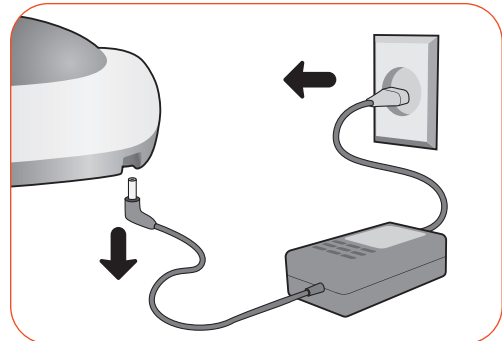

- ▶ Please the main body on a table, pull the right side of the main body out about a third as seen in the figure, pull out the water cap at the bottom of the main body, and water runs out. Here, tilt the main body from side to side to drain water from the main body completely.

⚠ Be careful not to lose the drain seal.

Tip: Place a basin under the table to catch water.

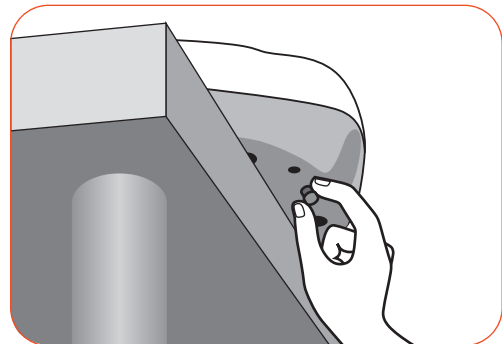

- ▶ Detach the floor head from the suction pipe of the vacuum cleaner.

- ▶ Open the view window of the incubator and place the suction pipe of the vacuum cleaner over air circulation hole at the fore part of the main body and start the cleaner to remove dust from the main body effectively. If there is alien substance near the egg roller, the machine can fail to work, so, vacuum cleans the roller, too. Then wipe over with a damp cloth, and make sure the incubator is dry before storage.



⚠ In case the incubator clean status is poor which may cause fan noisy or stopping.

Tip: As dried feather of chicks can form dust enter the main body during several courses of incubation, it is desirable to clean the product after each course of incubation.

- ▶ Clean the product with moist cloth and dry it in airy place before storing it.

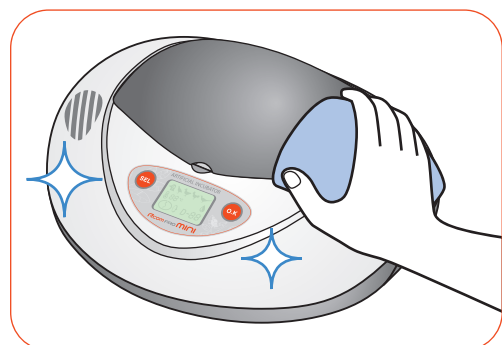

⚠ Don't clean the product with such organic solvents as benzene and paint thinner.

5. Raising of chicks

(1) Date of Hatching / Date for Stopping Rolling an Egg by Kinds of Birds
 (2) What Is a Fertilized or Unfertilized Egg?

● Date of Hatching / Date for Stopping Rolling an Egg by Kinds of Birds

Kinds of birds	Quail	Rooster	Duck	Pheasant	Turkey
Number of days to be spent until incubation	17	21	28	23	28
Date when stopping rolling eggs	14th day	18th day	25th day	20th day	25th day

Kinds of birds	Rigeon	Golden pheasant	Silver pheasant	Society finch	Parakeet
Number of days to be spent until incubation	17	23	23	14	19
Date when stopping rolling eggs	14th day	20th day	20th day	11th day	16th day

● What Is a Fertilized or Unfertilized Egg?

Fertilized Egg

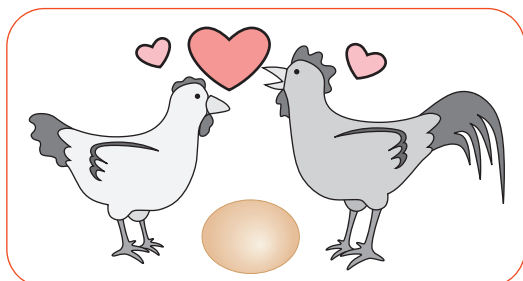

Fertilized egg is Simply speaking, it means an egg laid by mating a hen and a cook. So it can become a chicken.

Unfertilized Egg

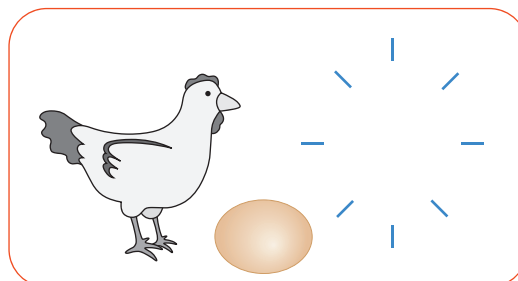

It is an egg we generally eat. As an unfertilized egg is laid by a hen alone, it cannot become a chicken.

● Purchase of Fertilized Eggs

It is important to purchase fresh fertilized eggs in order to increase success rate of incubation. You can purchase them from breeders.

It is desirable to see the date they were laid in order to select eggs that were laid within a week ; the older an egg is, the harder it is to hatch. It is also desirable to purchase eggs laid by a hen that is raised along with a cook in the country.

● Examination of an Egg

An egg is examined about three times during the course of incubation at a general hatchery.

[At a Dark place]

Place an egg horizontally on smooth cloth or towel, and turn on a candle and place gently to the large end of the egg, and you can observe blood vessels or an embryo's movement.

Tip : Observe it with the light switched off, for example, in a dark room by day.

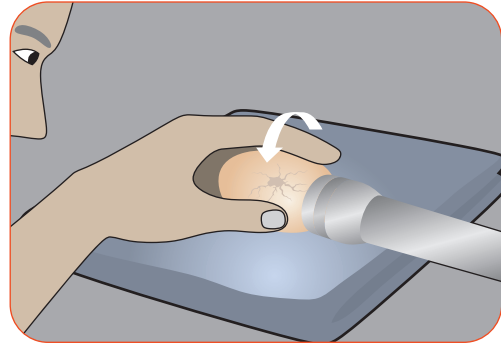

[First Examination]

6th day after incubation starts
Blood vessels look spidery and an embryo's movement can be identified on examining carefully.

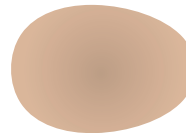

An unfertilized egg or a fertilized egg before incubation starts

[Second Examination]

12th day after incubation starts
Blood vessels become thicker and an embryo becomes bigger with brisker movements.
If blood vessels fail to be vivid or there is no movement, it can be an egg that stopped developing (dead).

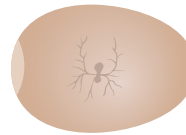

6th day



12th day

! If no blood vessel or embryo is observed, it is an unfertilized egg, which should be pulled out of the incubator.



18th day

[Third Examination]

18th day after incubation starts
As an embryo becomes bigger, all but an air chamber looks black. From this moment, stop rolling an egg.

! During the examination, the ambient temperature is lower than that in the incubator. For this reason, it is desirable to conduct this examination in a warm room in less than 10 minutes. Be careful not to give a shock to the egg. Even an excessive shake can cause the egg to die of stress.

! If a shell is thick or has a rich color, it can be difficult to observe an egg.

Tip : You can examine an egg every day since you aim at having observational learning; however, the more frequently you examine an egg, the higher the probability of failure in incubation.

5. Raising of chicks

(4) Process on chick incubation

On the 2nd day after incubation starts

The head to occur along with eyes and the heart and blood vessels start to grow.

4th day

Brains are divided into the forebrain, the midbrain, and the hindbrain.
The heart grows much bigger and blood vessels spread wide on the film of the yolk.

6th day

Wings and limbs begin to appear and brains and eyes become clear.
The embryo begins to move by itself.

8th day

Brains are settled in the head completely.
The neck becomes longer; the bill develops remarkably; and wings and limbs are separated.

10th day

Wings and limbs are separated completely and toes form.
Egg tooth begins to occur and feathers start to grow.

12th day

It becomes much bigger and begins to hear for the first time. Feathers grow so that you can see them and the framework becomes solid.

5. Raising of chicks

(4) Process on chick incubation

14th day

With the head lowered toward the trunk, the back is bent to the left. Feathers cover the entire body with the head toward the air chamber.

16th day

As the head moves to under the right wing, it settles down at a position good for hatching.

18th day

The amount of amniotic fluid decreases and the chick prepares for hatching. It is time to stop rolling an egg.

19th day

The air chamber becomes much bigger and the yolk is settled in the body. The bill is held out toward the air chamber and lung-breathing starts.

20th day

The Yolk is settled completely in the body and the navel hasn't closed yet. The yolk that entered in the body becomes a nutriment for two to three days after incubation.

21th day

The chick begins to use egg tooth to break the shell. Over time, it uses limbs to push the shell and turns round to break it round. Low humidity can cause dried-up feathers to stick to the shell, preventing the chick from turning round and thus from hatching. It takes about 12 hours to break the shell completely and get out of the egg.

● Making of a Nest for a Chick

Since new-born chicks are excessively sensitive to cold, it is necessary to keep them warm. The temperature of inside nest must be 35~37°C (95~98.6°F) So a nest is indispensable to raise young chicks. Use the packing box of the product purchased to make a nest for chicks.

- ▶ A low and heavy dish is good. (To prevent water from spilling even if the chicks step on it.) A bulb, a socket, and a cord can be purchased at hardware store.

⚠ Be sure to use a three-wavelength 20W bulb. If you use a bulb over 20W, temperature goes up, possibly killing the chick or causing a fire.

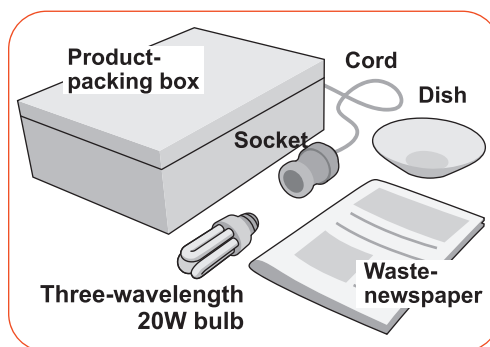

- ▶ Make 30mm of diameter holes on the back side of box 100mm from the bottom.

Tip: Refer when making a hole.
 Very cold place: Make a hole only at NO.1
 Cold place: No. 1, 2
 Warm place: No. 1, 2, 3
 Very warm place: 1, 2, 3, 5

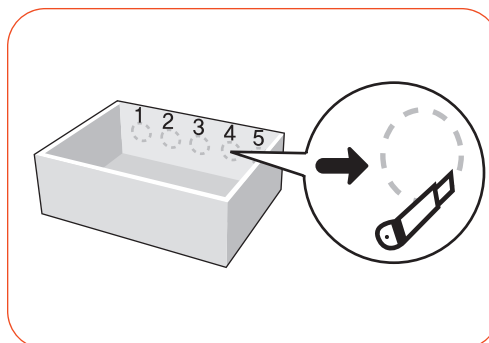

⚠ Be careful not to injure hands or other body parts with scissors.

- ▶ Insert the screw of the bulb in the hole inside the box, and the put the socket outside the box and fasten it.

⚠ Be sure to install the bulb without putting a plug in a socket. Or you can get a shock.

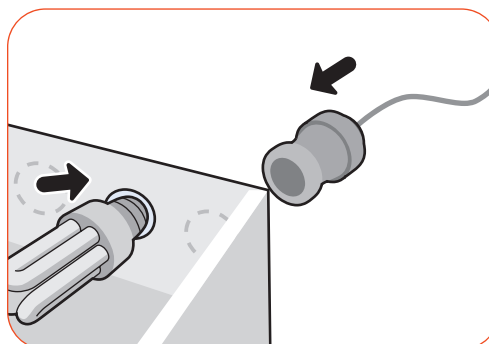

5. Raising of chicks

(5) Making of a Nest for a Chick

- ▶ Cover the bottom with newspaper, tape crosswise top of dish for chicks not falling into dish put the dish at the corner, and pour a little water into it.

! If there is too much water and a chick falls into water, its feathers will get wet and it can die of loss of body heat. Here, dry feathers with a hair dryer, etc.

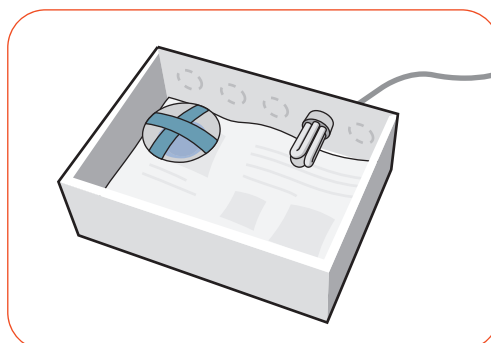

- ▶ About a day after chicks hatched, put them in the box and put the cover on. Put the plug in the socket and turn the light on.

Tip : About two weeks after chicks hatched, they have well-grown feather and becomes resistant to the circumstance. After that, you don't have to turn on the light.

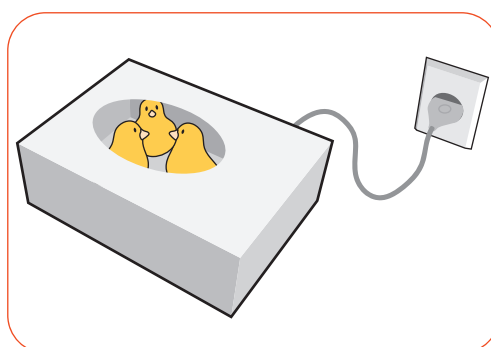

[Feeding of a chick]

A day after a chick hatched, it has soft feathers and is so cute!

Around this time, it can be fed first. Feed it on the chopped-up yolk of a boiled egg along with water in a dish. Don't feed it too much however cute it is. Because it doesn't eat so much.

It is desirable to mix it with a little soil or sand. A bird has a gizzard and sand will promote the digestion.

A chick likes to eat chopped-up lettuce or cabbage.

Feed a chick on the yolk of an egg for about two days, then on mix of the yolk and feed for chicks or hulled millet soaked in water, and on appropriate feed or moistened grains of cooked rice about a week later.

! If a chick peep-peeps loud, it needs a help. It falls into water and gets its feathers wet, feels cold, gets hungry or thirsty, feels lonely, or gets frightened. Only when you take good care of it, it never peep-peeps loud.

6. Product Information

(1) Frequently Asked Questions (FAQ)

● FAQ

For more detailed self-diagnosis, see Rcom homepage "SELF DIAGNOSIS" category.

The Rcom products are manufactured under strict quality management with precise equipments, but there may be some defects in the product during the distribution. If there is any problem please contact to the Service center or Distributor of Rcom. We will do our best to resolve the problem as soon as possible. The product is designed in module methods which is easily replaceable by any qualified person.

* E-mail reception : sales@autoelex.com

Circumstance	Items to be confirmed	Solutions
No signs of power to the incubator.	<ul style="list-style-type: none"> ▶ Check electric cord is properly connected. ▶ Check if there is a power outage. ▶ Check adaptor. 	<ul style="list-style-type: none"> ▶ Connect the cord again. ▶ Check the main socket with any other electric appliances. ▶ Try to insert to another outlet.
When temperature is too low	<ul style="list-style-type: none"> ▶ Check the incubator is operated. ▶ Check the pad with overflowed water. ▶ Check the air circulation FAN is working. 	<ul style="list-style-type: none"> ▶ Clean the FAN. (There could be foreign substance, such as egg shell.) ▶ Drain water in side of incubator, dry it under well ventilation.
When humidity is too low	<ul style="list-style-type: none"> ▶ Check for water shortages. ▶ Check the drain seal. 	<ul style="list-style-type: none"> ▶ Refill the water. ▶ If you don't have the drain seal, replace with eraser or rubber and tape it.
When eggs do not turn.	<ul style="list-style-type: none"> ▶ Put small object on the egg, wait for 1 hour and then small object is still on the egg. 	<ul style="list-style-type: none"> ▶ Initialize incubator and then restart incubator (Refer to the page 10)
The machine makes some noise. - A little noisy occurs from the inside of circulation fan.	<ul style="list-style-type: none"> ▶ Check whether you put anything on the incubator. ▶ Check if there is any vibration, or check the incubator set on a table. ▶ Check if there is any hatching debris such as feather or eggs-shell in the incubator FAN. 	<ul style="list-style-type: none"> ▶ Ensure the incubator is not touching any other items and nothing is on top of the unit. ▶ Move the incubator to a flat and even surface. ▶ Take out the plug out of the outlet and disassemble the main body and clean around the air circulation fan with brush.
Dew forms in the incubator. - Dew condensation is normal with high humidity incubation.	<ul style="list-style-type: none"> ▶ Check the incubator is filled with too much water. ▶ Check whether the incubator is moved or leaned side without draining water. 	<ul style="list-style-type: none"> ▶ When Styrofoam ball is rise, stop pouring water. ▶ Drain water completely inside of incubator and dry it under ventilation for one day.

 Test the incubator to be sure that the incubator works without any problem before placing eggs in the incubator. Please ensure you remember how to use the machine and maybe re-read instructions.

● Specifications

1-1 Name : Rcom PRO MINI
1-2 Model : PX-03

Power (Adaptor out-put)	DC12[V] ≡≡≡ 12[A] ADAPTOR
Power Consumption	Average 5[W] Max. 10[W]
Working Temperature	15 ~ 30[°C]
Capacity	3[EA] (Quil egg tray : 7[EA])
Weight	700[g]
Size	(W)260×(L)200×(H)110 [mm]

Extension of free service is not allowed for this product. The warranty period is one year from the date of purchase.

※ How to register the product online:

1. Go to www.rcom.co.kr
2. Click on “English”
3. Sign up for membership first, then log in using those credentials
4. Click “register products”
5. Fill in all required fields and click “Save”
6. Product registration is now completed.

※ Details required to register for the guarantee:

1. The name of the product model
2. The product serial number
3. Your purchase date
4. The name of the store of purchase

● **Guide to Consumer Damage Compensation**

This product cannot be registered as a free service extension. The warranty period is one year.

Types of Consumer Damage	Compensation History	
	Within warranty period	After the warranty period
In case of naturally occurred failure in function or performance in normal condition of use	Free repair	Paid repair
Failure in function or performance due to intention or error of the customer <ul style="list-style-type: none"> ▪ In case of failure due to natural disaster (fire, sea wind, gas, earthquake, storm and flood) ▪ When replacing expendable part normally abraded during the use ▪ Breakdown due to abnormal power source or faulty connection device ▪ Breakdown due to repair or remodelling by person any other than the service engineer of headquarters or the service center ▪ External factors which are not defect of the product ▪ Breakdown due to use of different rating voltage ▪ Breakdown due to use of consumable, optional product not designated by the company ▪ Breakdown or loss due to drop during the transportation ▪ Breakdown for not cleaning the product ▪ Breakdown due to use of other liquid than distilled or purified water ▪ Breakdown due to use of the incubator as brooder device (developer) ▪ Breakdown due to incorrect device control ▪ Breakdown due to manner of use not mentioned in the instruction manual ▪ If the customers' fault is clear 	Paid repair	

 **The success of incubation may vary according to different factors. The manufacturer and distributor are not responsible for failure of incubation of costly eggs, loss of life, property damage due to negligence of user, remodeling, painting, modification of purpose of use or power failure. When incubating parrot or costly birds please verify the internal temperature (adjust) before use. Please read carefully the instruction manual before use to avoid failures.**



Rcom is designed for user's easy and convenient use.
It can be changed without notice for improvement in performance, design,
treatment and software, etc.

Ver.3.7

www.Rcom.co.kr

SELLER

MANUFACTURER

AUTOELEX CO.,LTD.

- OFFICE : 218, Sangdong-ro, Gimhae-si,
Gyeongsangnam-do, 50805 Korea
- TEL : +82-55-337-2561
- E-MAIL : sales@autoelex.com

Choose for the best design, highest quality, value and performance!